

ZEFIRO 90 stainless steel

Ventilated hood for operators protection



Ventilated hood Zefiro 90 stainless steel

CODE CI09XX

Manufacturer: Diapath

Distributor: Diapath

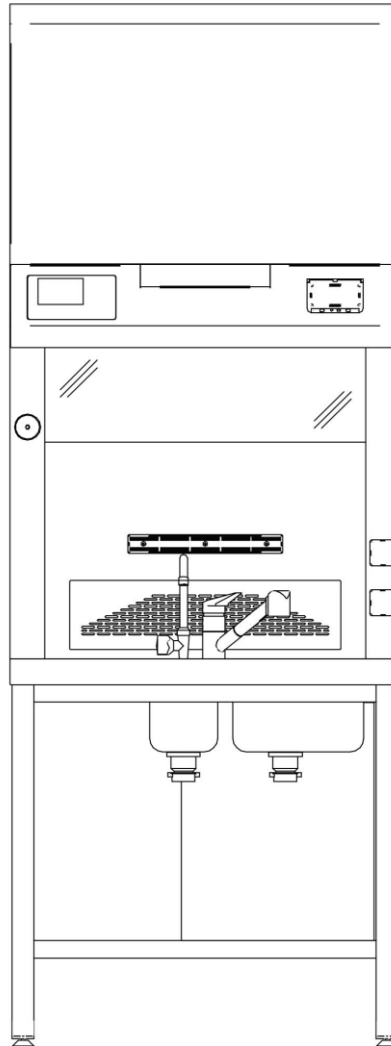

The picture above shows the product, but it is indicative for dimensions and equipped accessories

General features

The Zefiro ventilated hoods are designed to protect the operator during operations that could expose him to inhalation of harmful vapors.

The Zefiro ventilated hoods are modern modular suctioned working stations that, depending on the desired configuration, offer an optimal solution in every step of specimen processing.

The attention to manufacturing materials ensures reliability and durability, offering meanwhile an innovative line and a functional and attractive design.

Zefiro ventilated hoods, due to many configuration options, can also be used in fields not closely related to Pathological Anatomy.

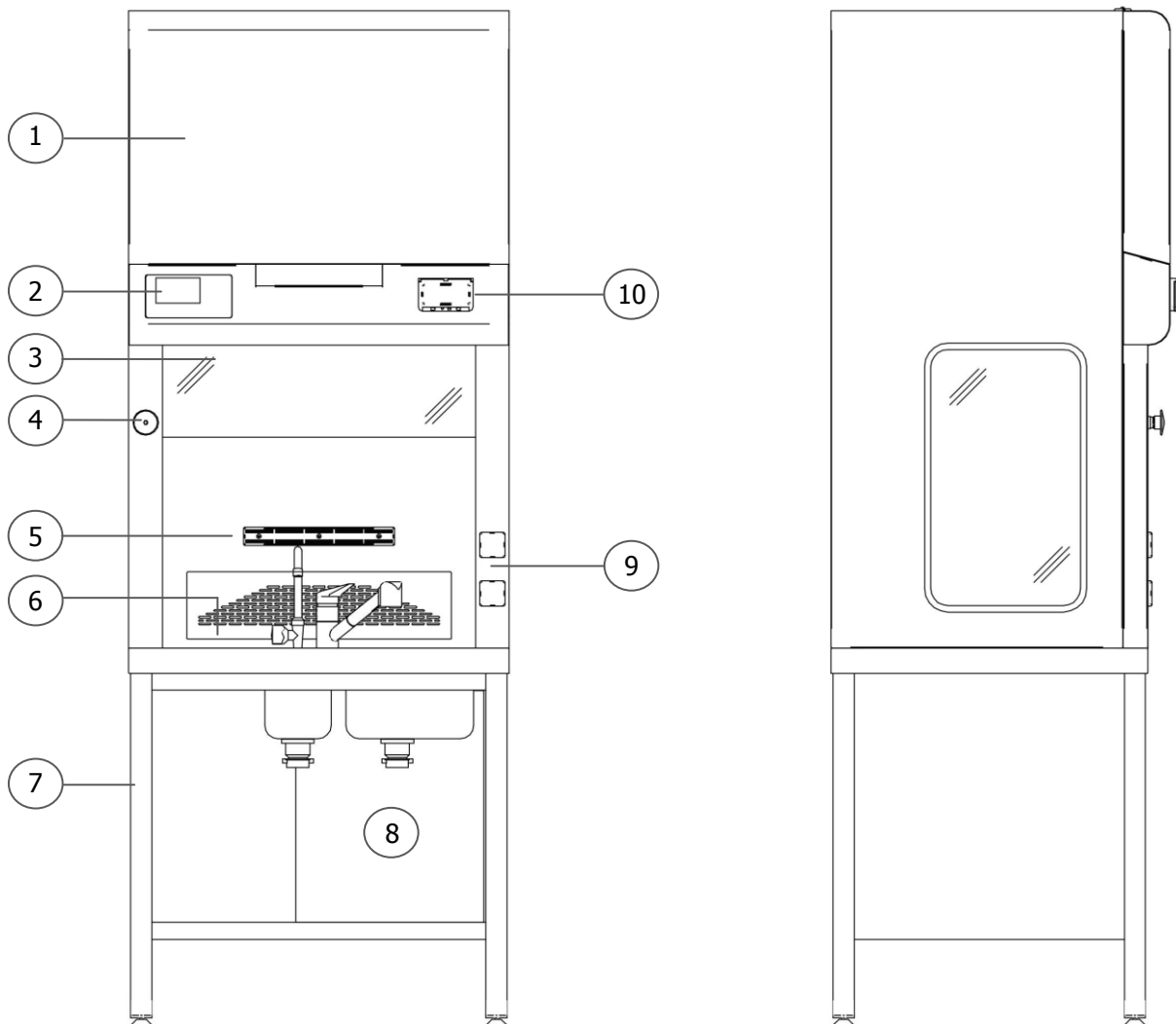

The picture above shows the product, but it is indicative for dimensions and equipped accessories

Overview

- | | | | |
|---|-----------------------|---|-----------------------|
| ① | Ventilated hood | ⑥ | Working plane |
| ② | Control panel | ⑦ | Base for hood |
| ③ | Movable shield | ⑧ | Hydraulic connections |
| ④ | Emergency push button | ⑨ | Sockets |
| ⑤ | Magnetic toolbar | ⑩ | General switches |

Overview

Ventilated hood

The structure is made of AISI 304 stainless steel, dimensions 900x750x1510 mm (WxDxH). Side walls with filter box and tempered glass

Control panel

Control panel with membrane keyboard, LCD display and electrical box with relay control board and circuit breakers with automatic release.

Movable shield

Made of tempered glass, sliding on polypropylene security guides, complete with motorized roller with position sensor (optional).

Emergency push button

Emergency system that, when pressed, brings the suction system to maximum speed. It is used in case of excessive leakage of liquids.

Magnetic toolbar

Magnetic toolbar for the positioning of tools used during specimens trimming.

Working plane

Working plane made of stainless steel (AISI 304 or AISI 316) or coated with melamine resin. Available in many configurations. Refer to the specific data provided in the section "Available Working Planes" (page 6).

Base for hood

Tubular structure, made of AISI 304 stainless steel, dimensions 900x750x900 (WxDxH), equipped with shoulders and fasteners.

- Side shoulders made of anticorrosive stainless steel
 - Support fasteners made of anticorrosive stainless steel
 - Equipped with rubber feet for hood stability and isolation
-

Hydraulic connections

Area used also as compartment for formalin tank (loading/unloading) tray, if foreseen.

Sockets (optional)

Group of n. 2 sockets with plastic cover having IP 45 door, protected by switches with automatic release.

General switches

The ventilated hood is equipped with a differential switch and with thermomagnetic switches.

Functions

Zefiro ventilated hoods offer a number of functions designed to make easier and more comfortable the operations performed by users.



Suction

Possibility to manage automatically or manually the fan speed. When automatically, the ventilated hood will manage fan operation in order to maintain the set average front speed, not considering glass position or filtering battery clogging level. When manually, the fan speed is set by the operator.



Function delay

Possibility to manage switching off delay of many functions, such as: suction, lighting, basin rinsing, waste disposal unit.



Basin rinsing (*)

Function of automatic rinsing basins located under the grid trimming planes. Possibility to set switching off delay of basin rinsing.



Formalin dispensing (*)

Automatic formalin loading system with software security management of delivery control. Unloading tank equipped with level sensor.



Waste disposal unit (*)

Waste disposal unit electronically started up via user interface. Possibility to set waste disposal unit switching off delay.



UV calendar (*)

Setting of the weekly calendar for switching on/off of UV lamp for disinfection of the working plane.



Spray calendar (*)

Setting of the weekly calendar for switching on/off of disinfection system by spray.

(*) Available according to ventilated hood working plane configuration

Filtering batteries

The Zefiro ventilated hoods are equipped with activated charcoal filters and, optionally, with absolute filters (HEPA). All filters are located in the hood compartment, to make the periodic replacement simple and safe.

Each filtering battery consists of: synthetic fiber prefilter, activated charcoal filter and, where foreseen, HEPA filter. Filters have a duration limited to the amount of chemical agent absorbed.

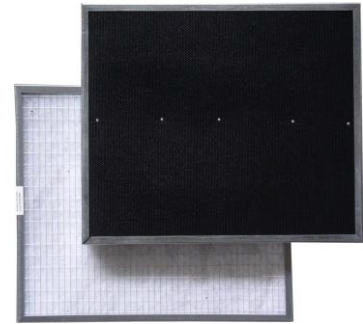

Synthetic fiber prefilter



The first part of the filtering battery is composed by elements made of synthetic fibers, able to remove bigger dust particles. The use of these filters (dim. 500x510 mm) prevents the premature clogging of activated charcoal filters, in order to increase the longevity and effectiveness of micro charcoal granules present in the next filter part.

Activated charcoal filter



The second filtering part consists on cells of 10Kg of charcoals activated by chemical processes. Micro granules present in these cells are able to filter the air removing molecules of harmful or even toxic fumes. The activated charcoal filters may be specific for filtration of formalin or generic.

Absolute filter (HEPA)



Optionally it is available a third filtering part consisting of absolute or HEPA filters, with an efficiency of 99.997%, able to filter particles of the size with only 3 microns. Filter HEPA CLASS 2 13P2 R11 691 Filtration <0,001% NaCl BS3928/M7605 CLASS S.

Diapath SpA, in its continuous effort to improve the service offered and the quality of its products, introduces in its ventilated hoods a patented electronic control system able to detect and save filtering battery expiry date. The filtering batteries must be periodically replaced with original spare parts approved and certified by the manufacturer.



Ventilation

The vapors containing harmful substances are suctioned by the nozzles located both on the upper and lower part of the ventilated hood compartment.



Exhaust fans

The equipped exhaust fan is designed according to the following factors: kind of hood, filtering battery (activated charcoal, absolute, anti-dust, etc ...), line of vapor exhalation, length of suction ducts.

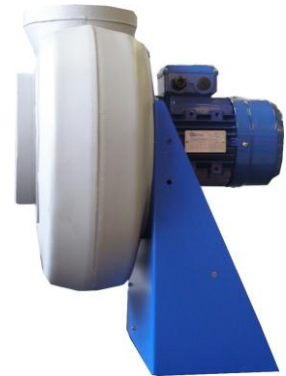

Remote exhaust fan 202 – SDCMT9004

Remote centrifugal exhaust fan model 202 with casing and impeller made of spark-proof plastic material

- Rated power: 0.18 KW

Remote exhaust fan 222 – SDCMT9005

Remote centrifugal exhaust fan model 222 with casing and impeller made of spark-proof plastic material

- Rated power: 0.25 KW

Remote exhaust fan 252 – SDCMT9006

Remote centrifugal exhaust fan model 252 with casing and impeller made of spark-proof plastic material

- Rated power: 0.37 KW

Remote exhaust fan 282 – SDCMT9007

Remote centrifugal exhaust fan model 282 with casing and impeller made of spark-proof plastic material

- Rated power: 0.75 KW

Remote exhaust fan 312 - SDCMT9008

Remote centrifugal exhaust fan model 312 with casing and impeller made of spark-proof plastic material

- Rated power: 1.5 KW

Available working planes

Code	<input type="checkbox"/> 00	<input type="checkbox"/> 01	<input type="checkbox"/> 03
Configuration	▪ Smooth plane	▪ Plane with cradle	▪ N°1 water sink WxDxH 300x400x200 mm

Base

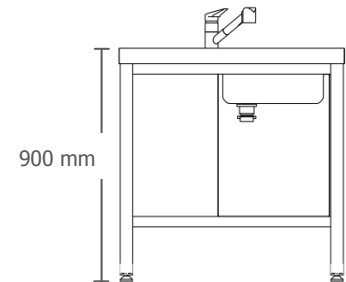
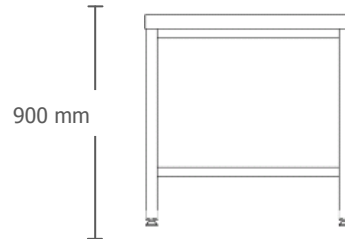
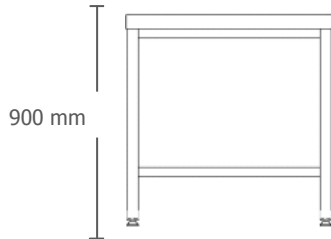

Working plane

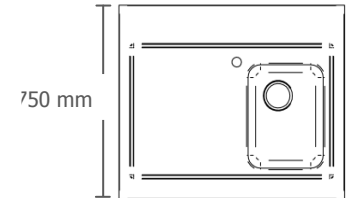
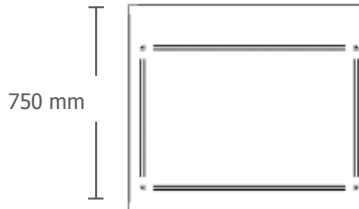
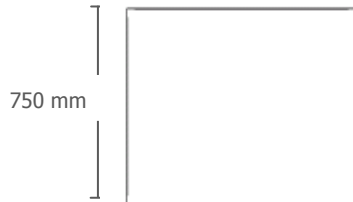

Code	<input type="checkbox"/> 05	<input type="checkbox"/> 09
Configuration	<ul style="list-style-type: none"> ▪ N°1 water sink WxDxH 300x400x200 mm ▪ N°1 formalin basin WxDxH 155x305x200 mm 	<ul style="list-style-type: none"> ▪ N°1 formalin basin WxDxH 155x305x200 mm

Base

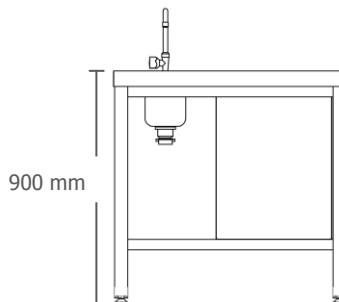
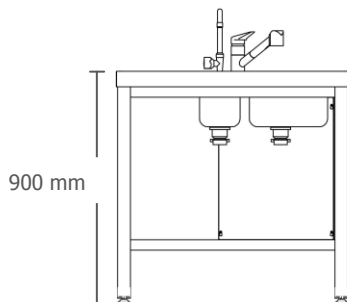

Working plane

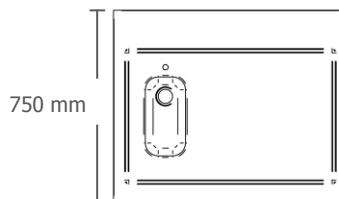
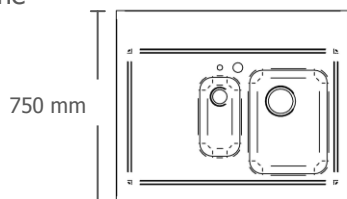

Codes in this page refer to working planes made of AISI 304 stainless steel. On demand are available working planes with the same configurations made of AISI316 stainless steel or coated with melamine resin (smooth plane)

Included with the product

- SDCPS9007 Foot pedal controlled water dispensing system (included with working planes 03 and 05)

Available accessories

The high quality standards of available accessories improve the operations performed daily by laboratory staff, ensuring that they are carried out safely.

<input type="checkbox"/>	SDCOP9001	Adjustable led spotlights
<input type="checkbox"/>	SDCOP9002	Glass height transducer
<input type="checkbox"/>	SDCOP9003	Stainless steel shelf for ventilated hood 90
<input type="checkbox"/>	SDCOP9007(*)	UV lamp for ventilated hood 90
<input type="checkbox"/>	SDCOP9009	Filters clogging control
<input type="checkbox"/>	SDCOP9010	Couple of sockets for stainless steel hoods
<input type="checkbox"/>	SDCOP9014	Foot pedal controlled formalin dispensing system (included with working planes 05 and 09)
<input type="checkbox"/>	SDCOP9016	Waste disposal unit (available on working planes 03 and 05)
<input type="checkbox"/>	SDCOP9017 (**)	Flowmeter for hose Ø 200
<input type="checkbox"/>	SDCOP9018 (**)	Flowmeter for hose Ø 250
<input type="checkbox"/>	SDCOP9024	Disinfecting spray with electronic control
<input type="checkbox"/>	SDCOP9026	3X magnifier lamp with bracket

(*) These optional require the presence of the shelf to be installed

(**) These optional require the presence of the glass height transducer to be installed

Technical features

Dimensions	<ul style="list-style-type: none"> ■ Width 900 mm ■ Depth 830 mm (max overall dimensions) ■ Total height 2410 mm (not inclusive of local motor) ■ Working plane height 900 mm ■ Sharp light 740 mm ■ Shield opening min. 200 mm – max. 700 mm ■ Internal compartment 835x540 mm
Total weight	<ul style="list-style-type: none"> ■ 225 Kg (different for each configuration)
Material	<ul style="list-style-type: none"> ■ Working plane Available: AISI304/AISI316 stainless steel, melamine resin (smooth plane) ■ Ventilated Hood AISI304 stainless steel ■ Base AISI304 stainless steel
Power	<ul style="list-style-type: none"> ■ 230VAC 50 Hz
Socket protection level	<ul style="list-style-type: none"> ■ IP55 internal socket ■ IP45 surface socket (optional)
Arrangements	<ul style="list-style-type: none"> ■ Water Hot water loading: 1/2" female Cold water loading: 1/2" female Water unloading: 1" 1/4 ■ Fume exhalation Ø 200 mm
Filtering battery	<ul style="list-style-type: none"> ■ 1 Filter made of synthetic anti-dust fiber ■ 1 Activated charcoal or generic filter ■ 1 HEPA filter, efficiency 99,97% (optional)
Exhaust fan	<ul style="list-style-type: none"> ■ Verify power specifics in the dedicated section
Speed setting	<ul style="list-style-type: none"> ■ Single-phase inverter sized according to exhaust fan model
Rumor	<ul style="list-style-type: none"> ■ <70 dB
Detection system for filtering battery replacement	<ul style="list-style-type: none"> ■ RFID antenna
Lighting system	<ul style="list-style-type: none"> ■ LED lighting system
Alarm for filter replacement	<ul style="list-style-type: none"> ■ Timer that counts the residual working time of filtering batteries and highlights the necessary replacement date
User interface	<ul style="list-style-type: none"> ■ LCD color 4,3" display with membrane control keyboard

Zefiro ventilated hoods are manufactured according to rule EN14175